

FURRION VISION S

Vision S Camera System

User Manual



* The packing contents may be different based on the kit you purchased. Please take the actual product as standard.

Models:

FOS07TASR / FOS07TASF / FOS07TAED / FOS07TAPT / FOS05TASR / FOS05TASF
FOS05TAED / FOS05TAPT / FOS43TASR / FOS43TASF / FCN48TASK / FCN48TASF
FCE48TASL / FOS43TDDC / FOS05TAEN / FSO07TAEN / FOS05TAEM / FOS07TAEM
FOS05TASM / FOS07TASM / FOS43TASM / FOS07TAPM

Welcome

Thank you for purchasing the Furrion® Vision S Camera System. Before operating your new product, please read these instructions carefully. This will ensure safe use and reduce the risk of injury. This instruction manual contains information for installation, maintenance of the product and safe use.

Please keep this instruction manual in a safe place for future reference. Be sure to pass on this manual to any new owners of this product.

The manufacturer does not accept responsibility for any damages due to not observing these instructions.

If you have any questions regarding our products, please contact us at: **support@furrion.com**

Contents

Welcome	2
Contents	3
Important Safety Instructions	4
FCC Statement.....	5
IC Statement.....	6
Care and Cleaning.....	7
Maintenance	7
Product Overview	8
Install and Use Monitor	12
Install and Use 4.3" Monitor.....	12
Install and Use 5"/7" Monitor	18
Install Cameras	28
Install Doorway Security/Rear Camera	28
Install Side Cameras & Rear Camera with Marker Light.....	31
Troubleshooting	34

Important Safety Instructions

Generic safety instructions

READ THESE INSTRUCTIONS CAREFULLY BEFORE INSTALLING OR USING THE SYSTEM

When used as an observation system, this product is intended to assist in safe driving and to allow the driver to have a broader view.

Do not back up your vehicle while watching the monitor screen. Always look in the direction the vehicle is traveling.

Use the monitor as an aid to ensure there are no children or obstructions. The image on the monitor is not designed to show distance and may be misleading. The actual distance is less than what appears in the monitor. The range of the image is limited. Be aware of blind spots.

You, as the driver, are solely responsible for the safe operation of your vehicle and the safety of your passengers according to your local traffic regulations.

Do not use any features of this system to the extent it distracts you from safe driving.

Your first priority while driving should always be the safe operation of your vehicle. Furrion cannot accept any responsibility for accidents resulting from failure to observe these precautions or safety instructions.

1. This product utilizes high voltage. Any unauthorized modifications or damage to the product may result in electrical shock. Handle all components with care. Inspect regularly for damage to components and cabling.
2. You are responsible for ensuring the installation of this product does not void or affect the vehicle manufacturer's warranty. Furrion is not liable in full or in part for improper installation resulting in loss or damage to your property, or for voiding all or part of the vehicle manufacturer's warranty.
3. Do not apply excessive force to any of

the components contained within this kit. Excessive force used before, during or after installation that results in a damaged or nonfunctional part will void all warranties.

4. Please follow the procedures in this instruction manual. Improper installation or modification of this product will void all warranties.

Many jurisdictions have laws and regulations relating to the use of cameras and some do not allow for the obstruction of information contained on a license plate. Before using this product, it is the buyer's responsibility to be aware of and comply with any applicable laws and regulations that apply to license plates or may prohibit or limit the use of cameras.

Electrical Safety

- Ensure all power sources are isolated before installation.
- Insulate unconnected wires with vinyl tape or similar.
- Use insulated tools when working with a power supply.
- For EU countries:
 - The Vision S product shall be powered by 12V or 24V external power supply, with a properly sized fuse or breaker (5A for 12V or 3A for 24V) mounted between the product and power supply.
 - The external power supply used with this product shall comply with the LPS (Limited Power Source) requirements or shall be a Power Source Class 2 (PS2) with less than 100W.

Caution

- There are no serviceable parts in the Furrion® Vision S Camera System. Do not disassemble or attempt any repairs.
- Install external fuses/breakers as required.

Important Safety Instructions

Installation

- Installation and wiring of this product require specialist skills. To ensure proper and safe installation, please seek a specialist technician.
- Only use supplied or recommended parts.
- Use watertight connectors for the camera power supply cable to power source.
- Connect the camera to a 12-24V DC circuit using 18AWG or larger cables.
- Ensure correct polarity of DC power supply to the camera.
- To reduce the risk of fire, connect the camera only to a circuit provided with a maximum branch-circuit over current protection device.
- Do not route wiring in areas that may get hot.
- Take necessary precautions when working at elevated levels.

Use

- Electrical appliances and overhead power lines can affect the wireless signal.
- Do not place the monitor in a location where it might hinder field of vision while driving.
- Consideration should be given to any airbags when installing the monitor. Do not place the monitor where it might hinder the airbag or become hazardous if the airbag is deployed.

Care

- Do not wash the vehicle with an automatic car wash or high pressure water. This may damage the camera.
- Clean the LCD screen with a microfiber cloth. Do not use coarse or abrasive materials.
- Do not use alcohol or ammonia based products to clean the LCD screen. Only use specialist screen cleaning products.
- Use a wet cloth to clean the camera lens. A dry cloth may scratch the camera lens.

FCC Statement

The equipment complies with RF exposure limits. This module is limited to installation in mobile or fixed applications. The antenna used for this transmitter must not be co-located or operating in conjunction with any other antenna or transmitter.

This device complies with Part 15 of the FCC Rules. Operation is subject to the following two conditions:

- (1) This device may not cause harmful interference.
- (2) This device must accept any interference received, including interference that may cause undesired operation.

NOTE: The Grantee is not responsible for any changes or modifications not expressly approved by the party responsible for compliance. Such modifications could void the user's authority to operate the equipment.

NOTE: This equipment has been tested and found to comply with the limits for a Class B digital device, pursuant to part 15 of the FCC Rules. These limits are designed to provide reasonable protection against harmful interference in a residential installation. This equipment generates, uses and can radiate radio frequency energy and, if not installed and used in accordance with the instructions, may cause harmful interference to radio communications. However, there is no guarantee that interference will not occur in a particular installation. If this equipment does cause harmful interference to radio or television reception, which can be determined by turning the equipment off and on, the user is encouraged to try to correct the interference by one or more of the following measures:

Important Safety Instructions

- Reorient or relocate the receiving antenna.
- Increase the separation between the equipment and receiver.
- Connect the equipment into an outlet on a circuit different from that to which the receiver is connected.
- Consult the dealer or an experienced radio/TV technician for help.

RF Exposure

The device has been evaluated to meet general RF exposure requirement.

To maintain compliance with FCC's RF exposure guidelines, this equipment should be installed and operated with a minimum distance of 20cm between the radiator and your body.

IC Statement

This device complies with Industry Canada licence-exempt RSS standard(s). Operation is subject to the following two conditions: (1) this device may not cause interference, and (2) this device must accept any interference, including interference that may cause undesired operation of the device.

RF Exposure

The device has been evaluated to meet general RF exposure requirement. To maintain compliance with RSS-102 — Radio Frequency (RF) Exposure guidelines, this equipment should be installed and operated with a minimum distance of 20cm between the radiator and your body.

Maintenance

Care and Cleaning

Though your monitor requires little care, you will still need to maintain its condition and performance by following the guidelines below.

- Keep the unit away from excessive moisture, or extreme heat or cold.
- Keep liquids away from the monitor.
- Occasionally clean the surface of the monitor with a soft cloth moistened with water or glass cleaner.



































































Only clean the monitor with dry cloth. Do not clean it with strong chemical agents or abrasive cleaners. Never spill liquid of any kind on the product. Do not allow residue or liquids to enter any part of the monitor as this may cause risk of electrocution. Always disconnect power before cleaning.

CAUTION: Never use solvents such as benzene, thinner or cleaners available commercially to clean the monitor.















































Product Overview

Furrion offers you abundant options to set up an observation / security system for your vehicle. You can mount Furrion Vision S products onto various types of RVs such as trailers and Class A/B/C motorhomes.

The full range of Vision S wireless monitor and camera products available for your selection is listed below, which are sold either separately or as part of a system. Check all items in your package against the 'What's in the box' section on the packaging box to ensure you have got all the items. You can click an icon below to jump to the corresponding section for detailed description.

Part Number	Description	Product
FOS07TASR	Vision S 7" Single Camera System with Marker Light	 +  +  +  + 
FOS07TASF	Vision S 7" Single Camera System	 +  +  +  +  + 
FOS07TAED	Vision S 7" 3-Camera System with Marker Lights	 +  +  +  +  +  + 
FOS07TAPT	Vision S 7" 4-Camera System with Marker Lights	 +  +  +  +  +  +  + 
FOS05TASR	Vision S 5" Single Camera System with Marker Light	 +  +  +  + 
FOS05TASF	Vision S 5" Single Camera System	 +  +  +  +  + 
FOS05TAED	Vision S 5" 3-Camera System with Marker Lights	 +  +  +  +  +  + 
FOS05TAPT	Vision S 5" 4-Camera System with Marker Lights	 +  +  +  +  +  +  + 
FOS43TASR	Vision S 4.3" Single Camera System with Marker Light	 +  +  +  + 
FOS43TASF	Vision S 4.3" Single Camera System	 +  +  +  +  + 
FCN48TASK	Vision S Rear Camera	
FCN48TASF	Vision S Doorway Security or Rear Camera	 + 
FCE48TASL	Vision S Side Cameras with Marker Lights for 5" or 7" Display	

Product Overview

FOS43TDDC	Vision S 4.3" Display	 +  + 
FOS05TAEN	Vision S 5" 3-Camera System with Side LED Marker Lights	 +  +  +  +  +  + 
FOS07TAEN	Vision S 7" 3-Camera System with Side LED Marker Lights	 +  +  +  +  +  + 
FOS05TAEM	Vision S 5" 3-Camera System with Side and Rear LED Marker Lights	 +  +  +  +  + 
FOS07TAEM	Vision S 7" 3-Camera System with Side and Rear LED Marker Lights	 +  +  +  +  + 
FOS05TASM	Vision S 5" Single Camera System with LED Marker Light	 +  + 
FOS07TASM	Vision S 7" Single Camera System with LED Marker Light	 +  + 
FOS43TASM	Vision S 4.3" Single Camera System with LED Marker Light	 +  + 
FOS07TAPM	Vision S 7" 4-Camera System with LED Marker Lights	 +  +  +  +  +  +  + 

Product Overview

Note: Product specifications are subject to change without prior notice.

Vision S Family Monitor Specification

	4.3" Monitor	5" Monitor	7" Monitor
Operating Voltage	8 – 30Vdc		
Wireless Frequency	2.4G		
Rx Sensitivity	-88dBm+/-3dBm		
Aspect Ratio	16:9		
Resolution	480x272	800x480	800x480
Max View on Screen	1	4	4
View Angle	L/R65,U50,D60		L/R80,U60,D70
Brightness	Min. 200cd/m ²	Min. 300cd/m ²	Min. 180cd/m ²
Contract	350:1	600:1	800:1
Power Consumption (@12V)	<500mA @12V (Backlight ON)		
	<300mA @12V (Backlight OFF)		
	<30mA @ 12V (Display OFF)		
Operating Temperature	-20°C to +60°C		

Product Overview

Vision S Family Camera Specification

	L/R Side Camera	Rear Camera	Doorway Camera
Operating Voltage	8 – 30Vdc		
Wireless Frequency	2.4G		
Wireless Range	>150m (open area)		
Delay Time	<250ms		
Tx Power	18dBm+/-1.5dBm		
Transmitting Speed	6Mbps (Single)		
Decompression Form	H.264		
Camera Pixel	720x480		
CMOS Size	1/3"		
IR Cut Filter	850nm automatic		
Optical Lens	F2.5		F2.0
View Angle	65°		120°
Image Distance	<12m		<5m
Power Consumption (@12V)	<350mA (IR OFF)		
	<500mA (IR ON)		
Operating Temperature	-20°C to +60°C		
Motion Detection Algorithm	By video camera software		

Vision S Family Camera Bracket Specification

	LED Marker	Marker Light Bracket	Sharkfin Bracket
Number of Poles	4	3	2
Wiring Color	Red — Voltage in Black — GND Yellow — Turn signal trigger (left/right) Brown — Marker Light Voltage in	Red — Voltage in Black — GND Brown — Marker Light Voltage in	Red — Voltage in Black — GND
Installation Position	RED for Rear Amber for Side (Left / Right)	RED for Rear Amber for Side (Left / Right)	Doorway, Rear





Install and Use Monitor

Install and Use 4.3" Monitor

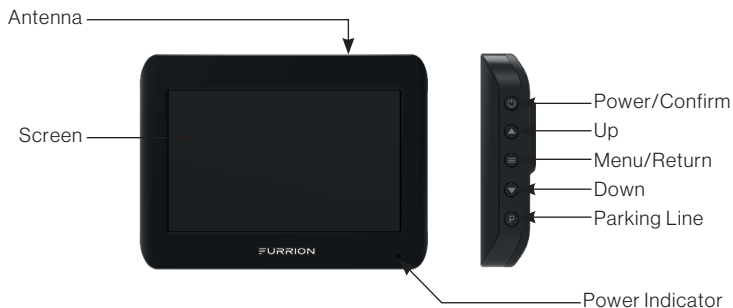
The Furrion Vision S 4.3" monitor is typically cab mounted and used as a rear observation system together with a Furrion rear camera.

Product overview



Button	Function
	<ul style="list-style-type: none">• Press briefly to power on.• Hold for 3 seconds to power off.• Press briefly to confirm your selection in each menu.
	<ul style="list-style-type: none">• Navigate up /down in each menu.
	<ul style="list-style-type: none">• Press briefly to switch between camera viewing and menu screens.• In a submenu, press briefly to return to the previous menu.
	<ul style="list-style-type: none">• Press briefly to show or hide the parking lines.

Install and Use Monitor

Install the monitor

IMPORTANT: Choose a monitor location in your vehicle that does not block your view and complies with local laws for safe driving. Do not place in an area where it might interfere with driving.

1. Clean the mounting area and remove the protective film from the suction cup of the windshield stand. Then place the suction cup onto the appropriate location and push the locking arm downwards to stick securely.

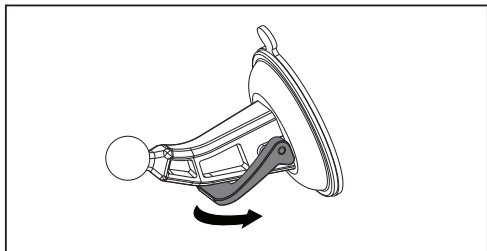

2. Align the ball on the bracket with the opening on the back of the monitor and push firmly to lock into place.

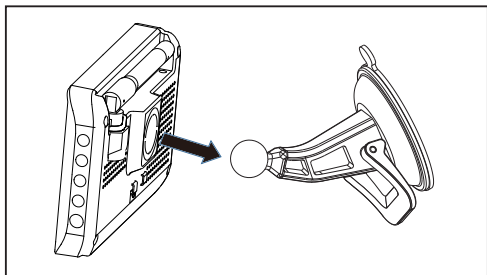

3. Connect the cigarette lighter connector of the monitor power cable to a cigarette lighter socket.

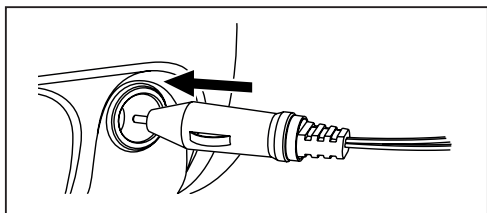

4. Connect the DC connector to the power socket on the monitor.

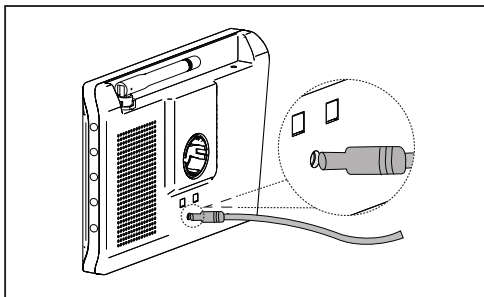

5. Rotate the monitor to adjust the visual angle as needed.

To remove the suction cup:

1. Lift up the locking arm.

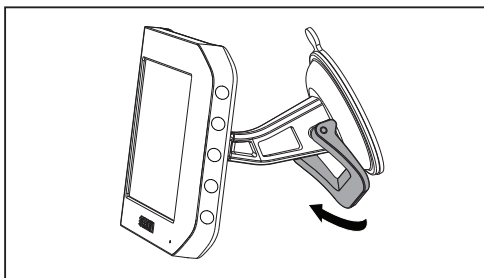

2. Pull the tab on the suction cup away from the windshield to allow air in then you can remove the suction cup easily.

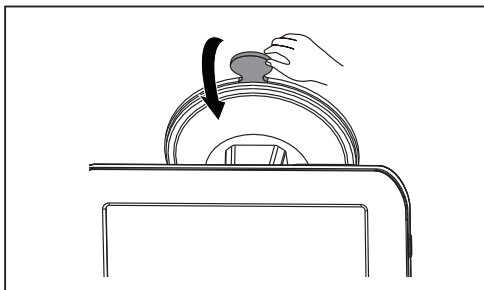

Install and Use Monitor

3. Detach the monitor from the windshiled mount.

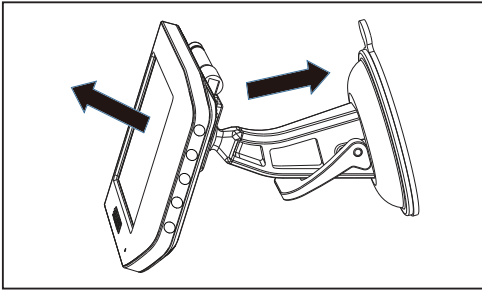

Pair with a rear camera

If this monitor comes in a bundle with a Furrion Vision S rear camera, it is paired with the camera by default. If you cannot find the video from the camera on the monitor screen or you have a standalone camera, follow the procedures below for pairing.

1. Ensure you have turned on the monitor and camera to be paired (see the installation and wiring section of the camera for details).
2. Press the **MENU** button on the right of the monitor to enter the setup menu.

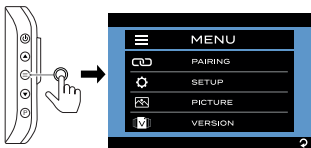

3. Tap **PAIRING** to enter pairing mode.



4. Press the **MONITOR PAIRING** button on the camera (rear camera shown) to pair it with the monitor.

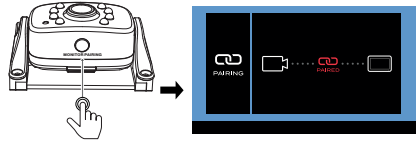

5. Erect antenna (if available) on the camera and ensure the signal strength is OK.



Good Signal



Poor Signal

Activate the Monitor

When the monitor is off:

Press the **POWER** button on the right of the monitor to turn it on.

When the monitor is on:

Press and hold the **POWER** button to activate the monitor.

NOTES:

- The camera transmits a clear and wide image with audio from the area behind the vehicle to the monitor inside. To avoid unnecessary noise when the vehicle is moving, you can mute your vehicle speaker system.
- When the monitor is off, it can turn on again automatically and display camera images after receiving a video signal on the 2.4GHz frequency band from the camera.
- The monitor adjusts color, brightness, and contrast automatically for either daytime or nighttime viewing. At night the picture will appear black and white. This is due to the low light level and is normal.

Install and Use Monitor

- The monitor in a wireless system is always watching for a video signal when it is off. Signals from other wireless camera systems may cause interference. For example, security cameras, baby monitors, and even other backup camera systems can also trigger the monitor to briefly light up. This is normal for wireless products.

Change Menu Settings

There are four menu options that allow you to set up the wireless rear observation system before operation.

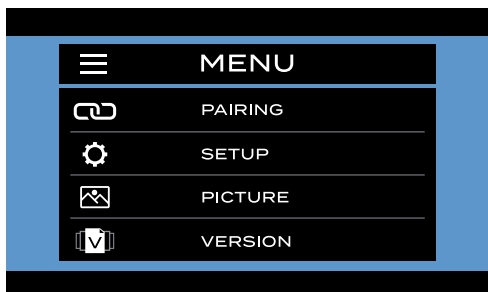

Camera Setting

Use ▲ / ▼ to highlight the **SETUP** menu, then press ⏻ to enter the next page or press ≡ to return to the previous page.



Mirror Setting

1. Use ▲ / ▼ to highlight the **MIRROR** menu, then press ⏻ to enter it.

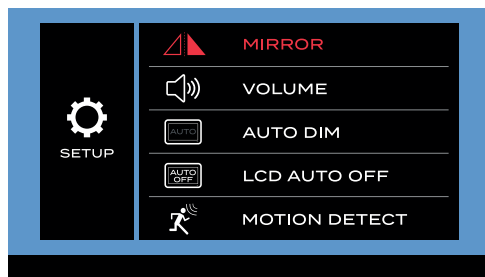

2. Press ▲ / ▼ to set the camera image as **NORMAL** (0°), **ROTATE** (180°), **FLIP** (Horizontal Mirror) or **FLIP & ROTATE** (Vertical Mirror). Press ⏻ to confirm your selection or press ≡ to return to the previous page.

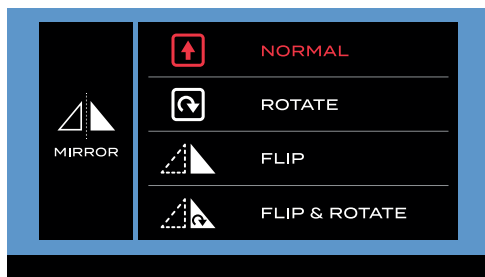

Volume Setting

1. Use ▲ / ▼ to highlight the **VOLUME** menu, then press ⏻ to enter it.

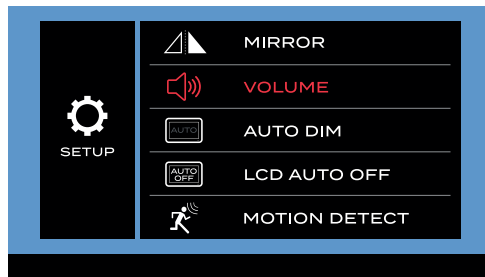

Install and Use Monitor

2. Press ▲ to increase volume or press ▼ to decrease volume.



Auto Dim Setting

1. Use ▲ / ▼ to highlight the **AUTO DIM** menu, then press ⏻ to enter it.

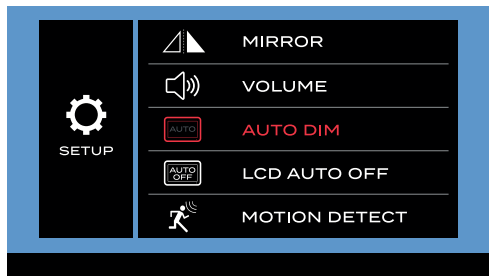

2. Use ▲ / ▼ to select ✓ or X. Press ⏻ to confirm your selection or press ≡ to return to the previous page. Press ✓ or X to enable or disable the light detect function.



LCD Auto Off Setting

1. Use ▲ / ▼ to highlight the **LCD AUTO OFF** menu, then press ⏻ to enter it.

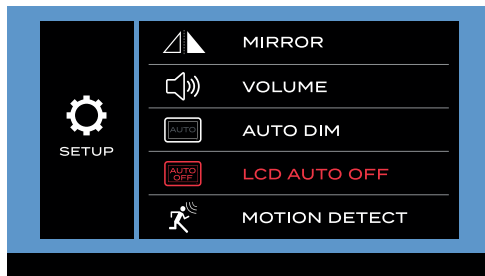

2. Press ▲ / ▼ to set the LCD auto off time as **10 SEC**, **20 SEC**, **30 SEC** or **X** (off). Press ⏻ to confirm your selection or press ≡ to return to the previous page.



Motion Detect Setting

When this function is enabled while the monitor is off, it will turn on again automatically after any motion is detected by the camera.

1. Use ▲ / ▼ to highlight the **MOTION DETECT** menu, then press ⏻ to enter it.

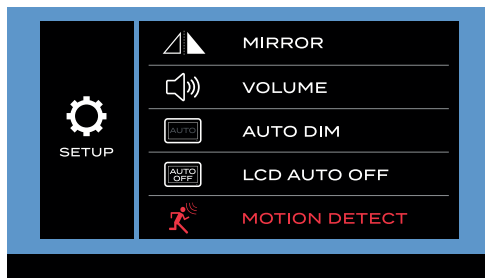

Install and Use Monitor

2. Press ▲ / ▼ to set the camera detection sensitivity as **LOW**, **MEDIUM**, **HIGH** or **X** (off). Press ⏻ to confirm your selection or press ≡ to return to the previous page.



Notes:

- The higher the detection sensitivity the easier the motion will be detected. Set **MOTION DETECT** to **HIGH** if you want the camera to be highly sensitive to objects moving across its detection area.
- In certain situations, the motion of some objects may cause undesired trigger actions. This is not a malfunction.

Picture Setting

1. Use ▲ / ▼ to highlight the **LCD AUTO OFF** menu, then press ⏻ to enter it.

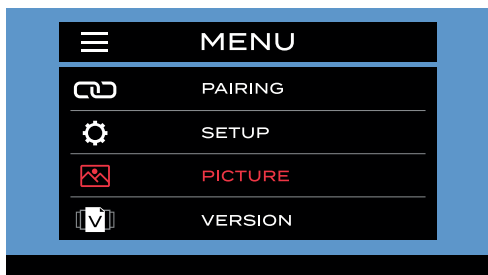

2. Use ▲ / ▼ to highlight the **BRIGHTNESS**, **CONTRAST** or **COLOR** menu, then press ⏻ to enter it.



3. Press ▲ or ▼ to change the **BRIGHTNESS**, **CONTRAST** or **COLOR** setting. Press ⏻ to confirm your selection or press ≡ to return to the previous page.

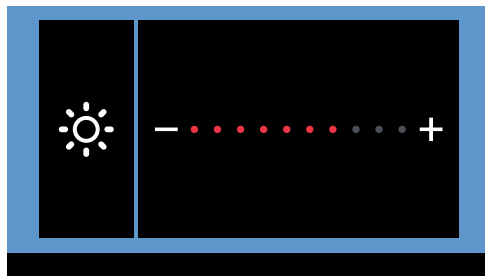

Software Version

Use ▲ / ▼ to highlight the **VERSION** menu, then press ⏻ to enter and view the current software version.

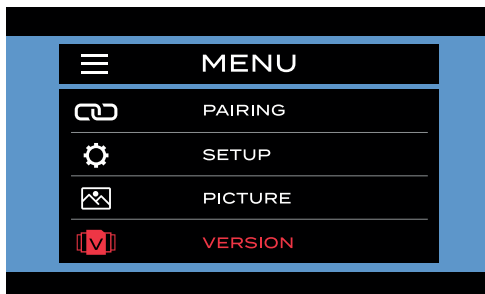

Install and Use Monitor

Install and Use 5"/7" Monitor

When mounted in the cab, the Furrion Vision S 5"/7" monitor typically works as an observation system together with a Furrion rear mounted camera (for rear observation) and two side cameras (for traffic observation).

When mounted in the coach, the Furrion Vision S 5"/7" monitor typically works as a security system together with a Furrion doorway camera.

Product overview

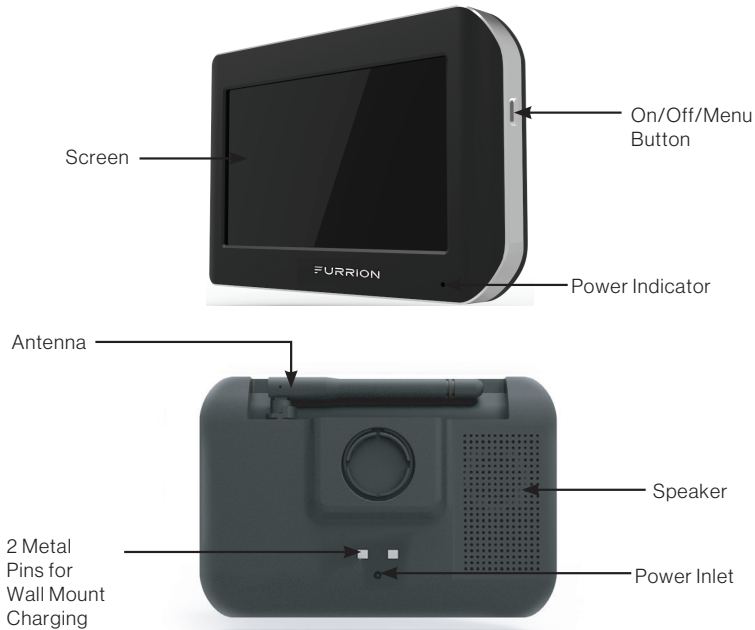

Install and Use Monitor

Prepare

- Prepare tools you may need, including a #2 Phillips head screwdriver, insulation tape, pencil and/or a 5/8" drill bit (needed only when drilling a new hole).

Install the monitor

Mount in cab for observation

IMPORTANT: Choose a monitor location in your vehicle that does not block your view and complies with local laws for safe driving. Do not place in an area where it might interfere with driving.

1. Choose a mounting method.

When using the windshield stand:

Clean the mounting area and remove the protective film from the suction cup. Then place the suction cup onto the appropriate location and push the locking arm downwards to stick securely.

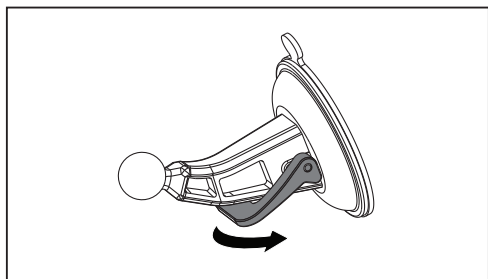

When using the table stand: Place the table stand designed with four non-slip pads on a stable surface, and route the monitor power cable as shown.

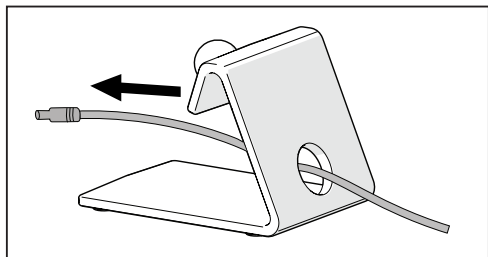

2. Align the ball on the bracket with the opening on the back of the monitor and push firmly to lock into place.

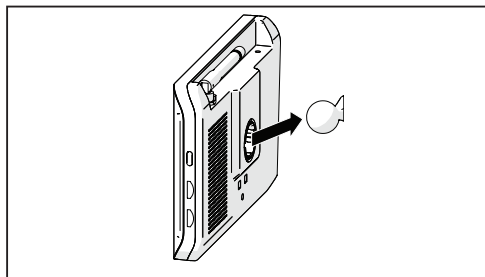

3. Connect the cigarette lighter connector of the monitor power cable to a cigarette lighter socket.

NOTE: There is a 12V 1A inline fuse under the plunger of the cigarette lighter plug.

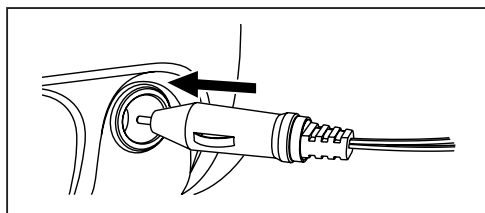

4. Connect the DC connector to the power socket on the monitor.

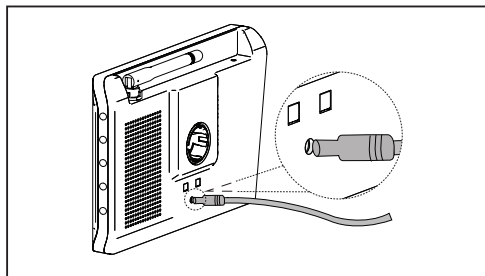

5. Rotate the monitor to adjust the visual angle as needed.

Install and Use Monitor

Pair with a camera

If this monitor comes in a bundle with one or more Furrion Vision S cameras, it is paired with the camera(s) by default. If you cannot find the video from the camera on the monitor screen or you have a standalone camera, follow the procedures below for pairing.

Note: For bundles with a sharkfin camera but no rear camera (such as FOS05TASF / FOS07TASF), the sharkfin camera is paired to the **REAR CAM** channel instead of the **DOOR CAM** channel by default.

1. Ensure you have turned on the monitor and camera(s) to be paired (see the installation and wiring section of each camera for details).
2. Press the **MENU** button on the right of the monitor to enter the setup menu.

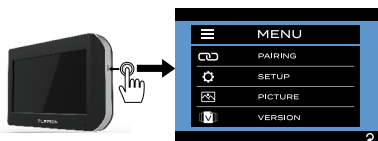

3. Tap **PAIRING** and then select the camera to be paired with the monitor.

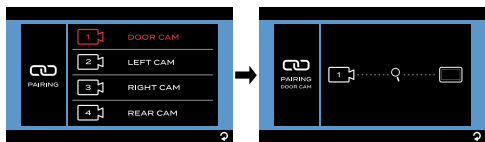

4. Press the **MONITOR PAIRING** button on the camera (doorway security/rear camera shown) to pair it with the monitor.

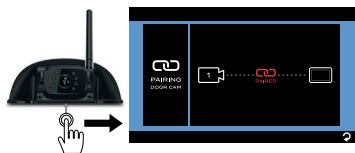

5. Repeat the steps to pair the other available cameras. Erect antennas (if available) on both the monitor and camera(s). Ensure the signal strength is OK.



Good Signal



Poor Signal

6. Tap to choose a view mode and then a camera for view as you like.

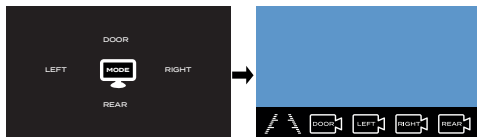

Activate the Monitor

When the monitor is off:

Press the **Menu** button on the right of the monitor to turn it on and enter the menu setting page.

When the monitor is on:

Press and hold the **Menu** button to activate the menu setting page.

NOTES:

- The rear or doorway camera transmits a clear and wide image with audio from the area behind the vehicle or at the vehicle door to the monitor inside. To avoid unnecessary noise when the vehicle is moving, you can mute your vehicle speaker system.
- The side cameras transmit clear images at both sides of your vehicle to the monitor.
- When the monitor is off, it can turn on again automatically and display camera images after receiving a video signal on the 2.4GHz frequency band from a camera.
- The monitor adjusts color, brightness, and contrast automatically for either daytime or nighttime viewing. At night the picture will appear black and white. This is due to the low light level and is normal.
- The monitor in a wireless system is always watching for a video signal when



Install and Use Monitor

it is off. Signals from other wireless camera systems may cause interference. For example, security cameras, baby monitors, and even other backup camera systems can also trigger the monitor to briefly light up. This is normal for wireless products.

Touchscreen operation

When in quadrant mode:

IMPORTANT: Quad view mode is not recommended for observation while you are driving.

1. Tap the center of the monitor screen to show the  icon.
2. Tap  to switch between **TRI-View**, **QUAD SPLIT** and **H SPLIT**.

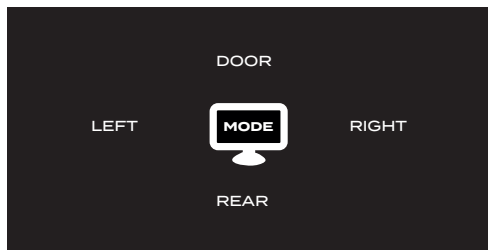
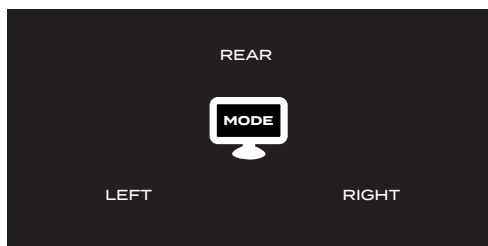





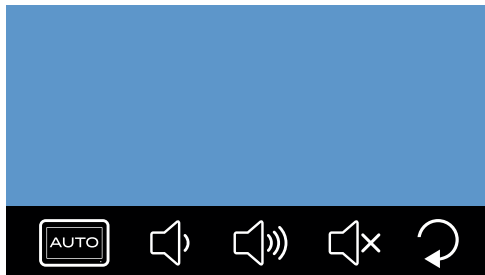

3. Tap **DOOR** (not available in TRI-View mode), **LEFT**, **RIGHT** or **REAR** to select a camera and view the image from it.

When in single channel mode:

Tap once on the monitor screen to bring up the camera selection interface.



Icon	Description
	Tap to turn on/off the on-screen guideline. <ul style="list-style-type: none">• In multi channel mode with DOOR, LEFT and RIGHT selected, tap  to enter Parking mode with on-screen guideline.• In single channel mode with REAR selected, tap once to enter the parking lines of rear view; tap twice to enter Parking mode with on-screen guideline. The selected mode will remain for 30 seconds before returning to the previous mode.
	Tap to select the door camera.
	Tap to select the left camera.
	Tap to select the right camera.
	Tap to select the rear camera.

Tap twice on the monitor screen to show the control menu. It will stay 5 seconds, then go back to previous single camera view.

Install and Use Monitor

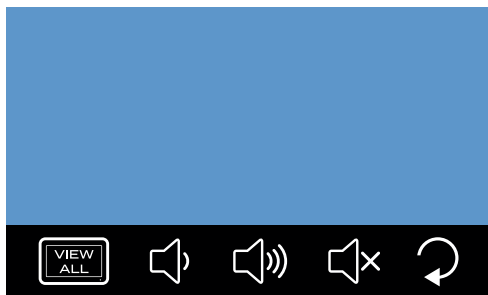

Icon	Description
	Tap to enter quadrant mode. The selected mode will remain for 10 seconds before returning to the previous single channel mode.
	Tap to decrease the volume of the monitor.
	Tap to increase the volume of the monitor.
	Tap to mute the monitor.
	Tap to return to the previous page.

Change Menu Settings

There are four options that allow you to set up the wireless vehicle observation / security system before operation.

Tap one of the four options to enter the setting page or tap ↻ to return to the previous page.

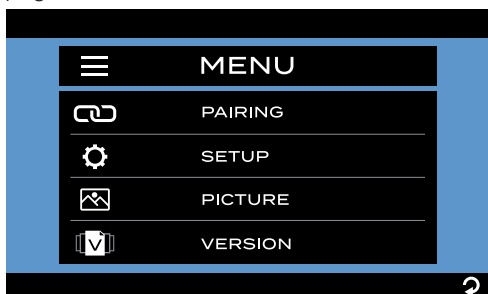

Camera Setting

Tap **SETUP** to highlight it in red and enter the submenu automatically.

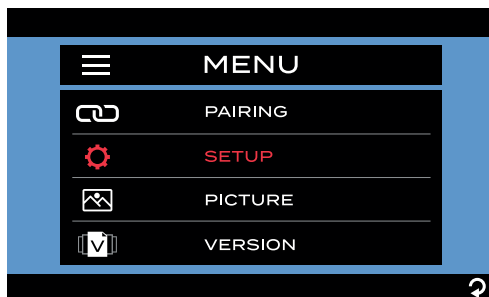

Auto Display Setting

When this function is enabled, the monitor can switch back to single-channel display mode automatically after the monitor stays in 3-channel or 4-channel display mode for 10 seconds.

1. Tap **AUTO DISPLAY** to enter the submenu.

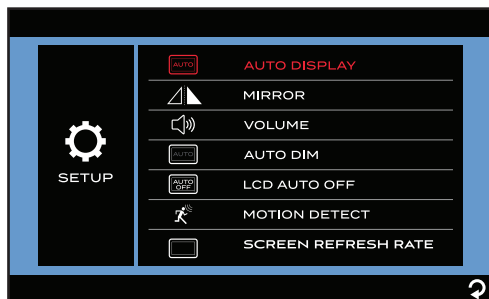

2. Tap the **AUTO DISPLAY** switch to highlight it red and enable this function. Here, you can tap **QUAD-View** to enter the sub-menu and select **QUAD SPLIT** or **H SPLIT** camera layout for 4-channel display or tap **TRI-View** to select the camera layout pattern for 3-channel display.

Install and Use Monitor

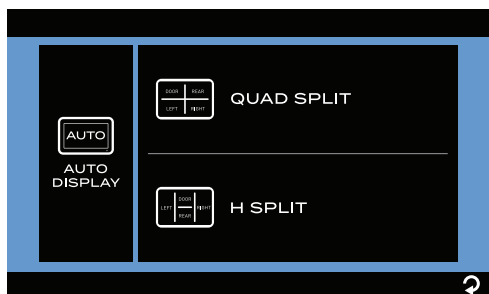
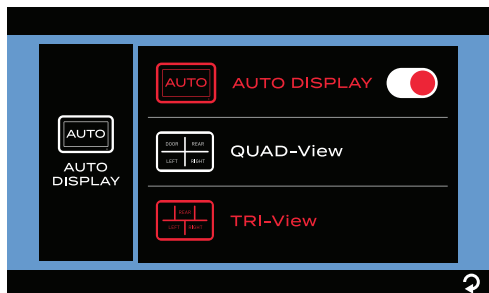

By default, the monitor screen shows the single-channel image of the last paired camera.

To switch to 3-channel or 4-channel display mode:

Tap twice on the monitor screen to bring up the camera selection interface, then tap

 to enter channel display.

- 3-channel display when **TRI-View** is selected:

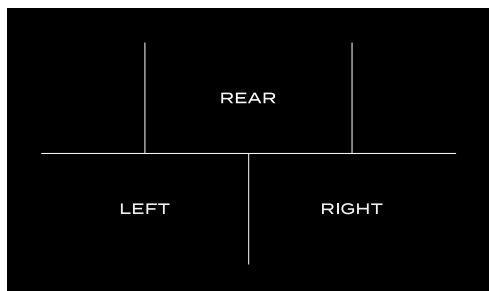

- 4-channel display when **QUAD SPLIT** is selected:

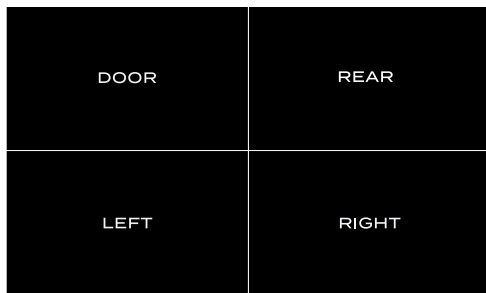

- 4-channel display when **H SPLIT** is selected:

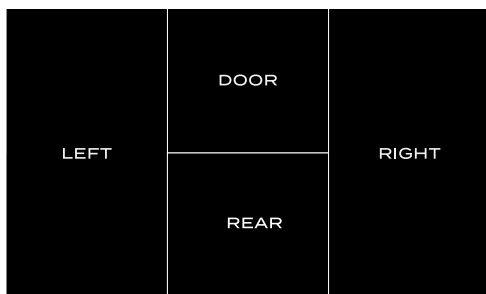

On the channel display interface, you can tap a specific section to enter the respective single-channel display mode, no matter whether the **AUTO DISPLAY** switch is enabled or disabled.

Mirror Setting

Install and Use Monitor

1. Tap **MIRROR** to enter the submenu. The currently selected setting will be highlighted red.

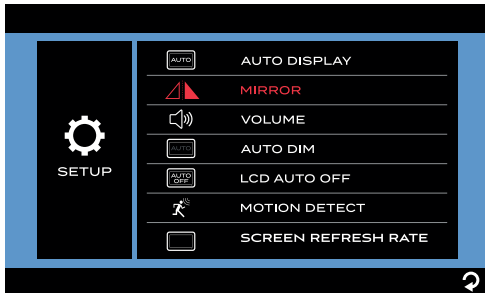

2. Select the camera you are going to set.

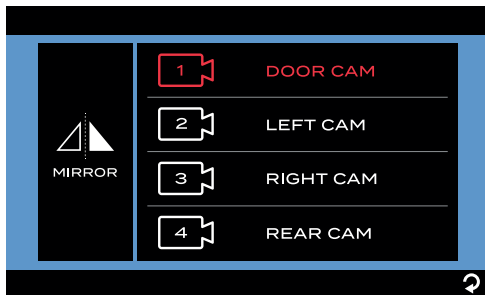

3. Tap to set the camera image rotation angle as **NORMAL** (0°), **ROTATE** (180°), **FLIP** (Horizontal Mirror) or **FLIP & ROTATE** (Vertical Mirror).

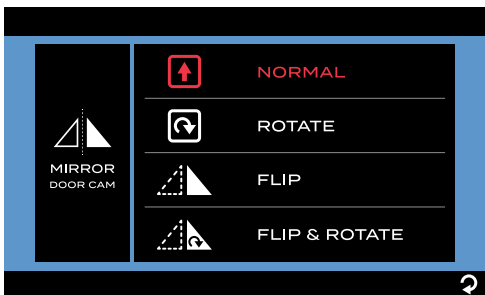

4. Repeat steps 2 and 3 to set the other cameras.

Volume Setting

1. Tap **VOLUME** to enter the submenu.

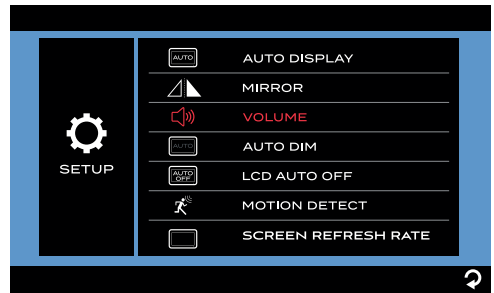

2. Tap **X** or **+** to decrease or increase the volume of the doorway and/or rear cameras.

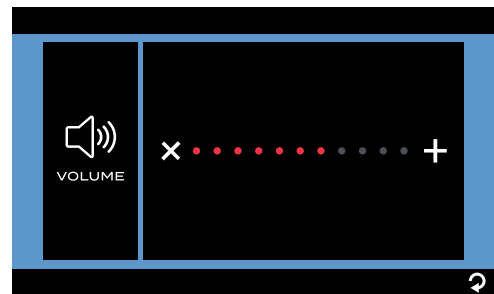

Auto Dim Setting

1. Tap **AUTO DIM** to enter the submenu.

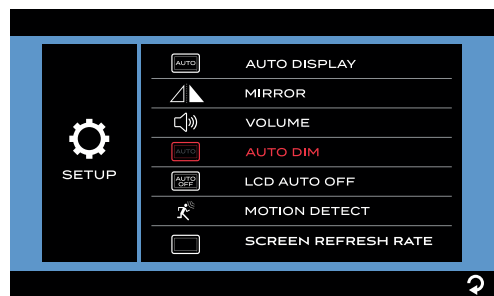

2. Tap **✓** or **X** to enable or disable automatic screen brightness adjustment.

Install and Use Monitor

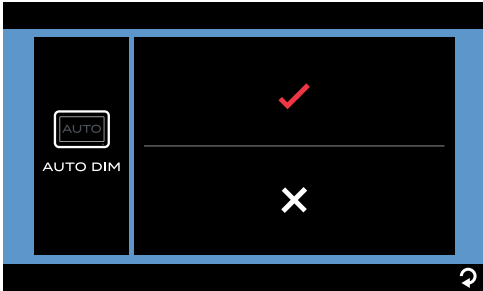

LCD Auto Off Setting

1. Tap **LCD AUTO OFF** to enter the submenu.

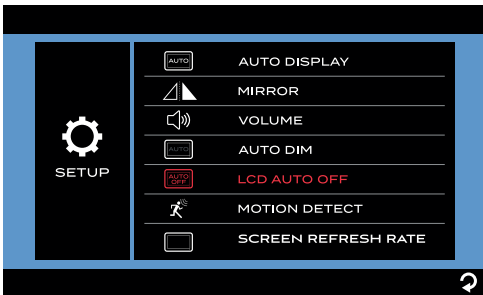

2. Tap to set the LCD auto off time as **10 SEC**, **20 SEC**, **30 SEC** or **X** (off).
When the LCD display is off, you can press the **Menu** button on the right of the monitor to resume display.

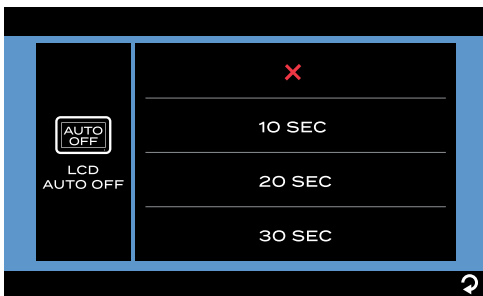

Motion Detect Setting

When this function is enabled while the monitor is off, it will turn on again automatically after any motion is detected by a camera.

1. Tap **MOTION DETECT** to enter the submenu.

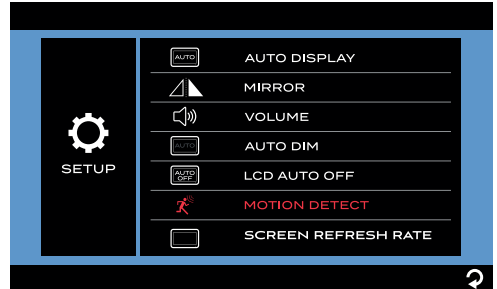

2. Tap to set the camera detection sensitivity as **LOW**, **MEDIUM**, **HIGH** or **X** (off).



Notes:

- The higher the detection sensitivity the easier the motion will be detected. Set **MOTION DETECT** to **HIGH** if you want the camera to be highly sensitive to objects moving across its detection area.
- In certain situations, the motion of some objects may cause undesired trigger actions. This is not a malfunction.

Install and Use Monitor

Screen Refresh Rate Setting

Here you can set a suitable screen refresh rate for the monitor. Screen refresh rate indicates the number of times in a second that the monitor redraws the screen image.

1. Tap **SCREEN REFRESH RATE** to enter the submenu.

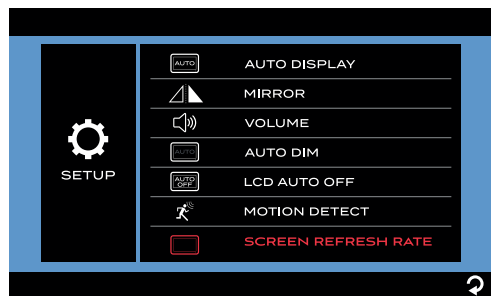

2. Tap to set the screen refresh rate to **60HZ** or **50HZ**.

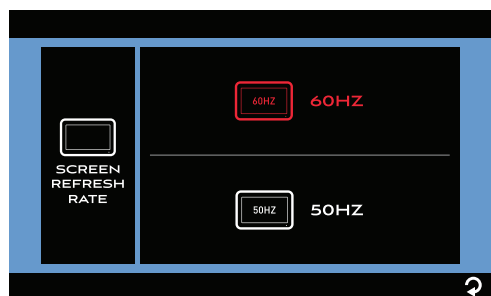

Picture Setting

1. Tap **PICTURE** to highlight it in red and enter the submenu automatically.

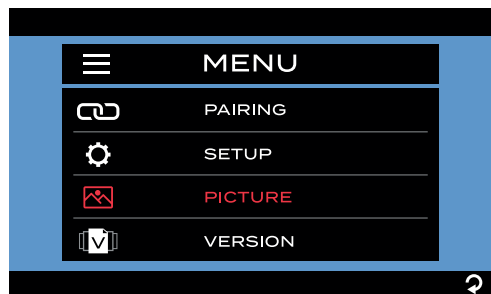

2. Select the camera you are going to set.

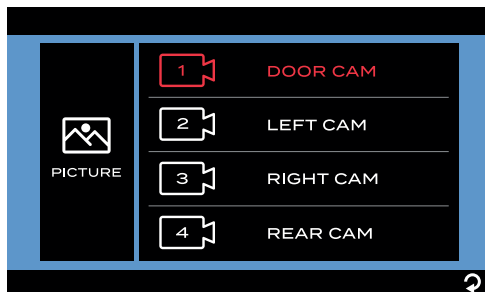

3. Tap **BRIGHTNESS, CONTRAST** or **COLOR** to enter the submenu.

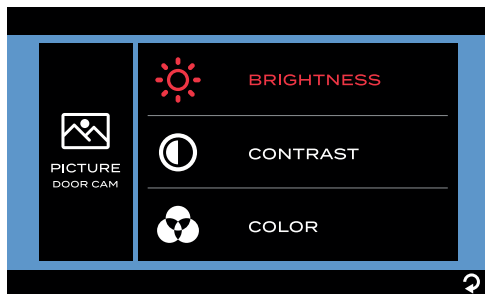

4. Tap **-** or **+** to change the settings.

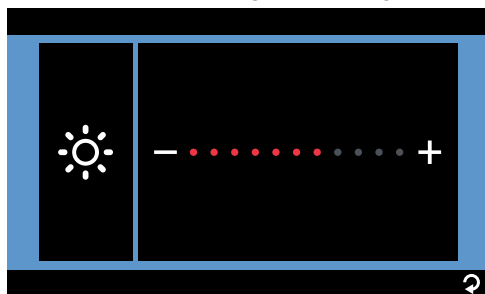

5. Repeat steps 2 to 4 to change the other camera(s) settings.

Install and Use Monitor

Software Version

- Tap **VERSION** to show the software version of the monitor and the current paired camera(s).

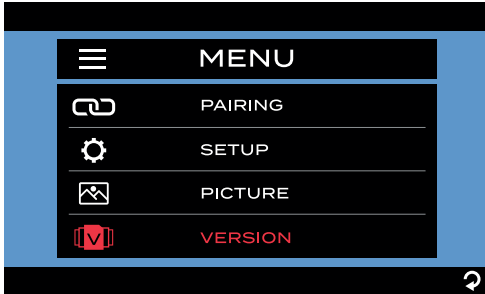

Install Cameras

Install Doorway Security/Rear Camera

Product overview

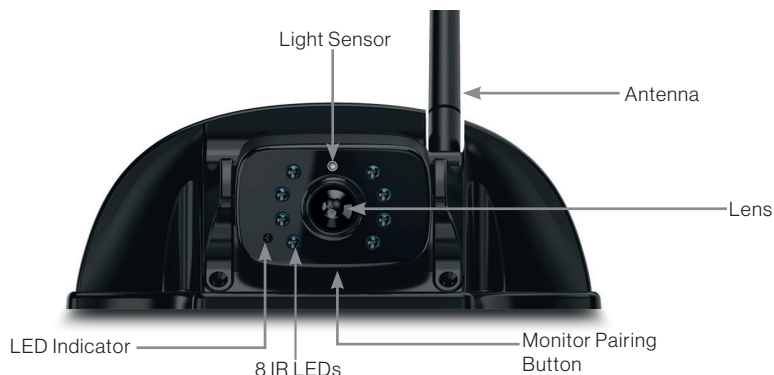

Prepare

- Prepare tools you may need, including a #2 Phillips head screwdriver, sealant, insulation tape, pencil and/or a 5/8" drill bit (needed only when drilling a new hole).

Mount bracket

Note: Skip this section if your RV is pre-installed with a bracket for camera installation.

IMPORTANT: Before any installation and wiring operation, remove the key from the ignition and isolate the 12V / 24V power source.

Always seek professional assistance if you are unsure about the installation and wiring operation.

1. Determine the mounting location on your RV. Ensure that there is no obstacle blocking the camera view. The recommended mounting location is shown below:
 - **For rear camera position:**
At the top center on the rear of your RV and as high as practicable (2" below the red marker light if available).
 - **For doorway camera position:**
Above the top of the door.

Note: The RV shown here is for reference only. You can mount Furrion Vision S products onto various types of RVs such as trailers and Class A/B/C motorhomes.

Install Cameras

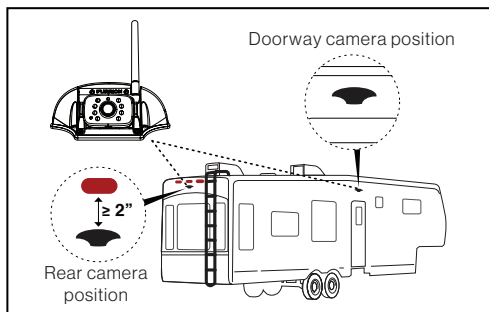

- Use the gasket as a template to mark a basic outline on the chosen location with a pencil. Drill a 5/8" center hole. Then route the female connector of the camera power cable through the hole and leave 2 inches of slack.

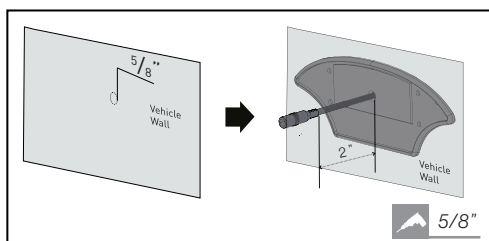

- Connect the bare ends of the camera power cable to the nearest 12V / 24V power supply.
 - For rear camera position:** You are suggested to share the same power line from the nearest marker light (such as the red marker light at the top center on the rear if available).
 - For doorway camera position:** You are suggested to share the power line from your RV porch light (or the nearest light source from the RV/trailer battery).

Note: Ensure that the fuse on the connected power line provides additional 1A fusing current for the camera. Ensure proper cable isolation for all bare ends (e.g., by using insulation tape).

- Fix the gasket and bracket with four #6x3/4" flat self-tapping screws. If the mounting surface is uneven, apply sealant between the gasket and RV surface, and around the 5/8" holes at the screw locations for better sealing.

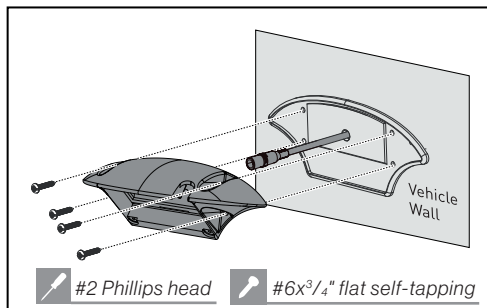

Mount camera

If this camera comes in a bundle with a Furrion Vision S monitor, it is paired with the monitor by default. You can connect it to the female connector on the Y type power cable of the monitor and resume power temporarily to check the pairing status before installation.

If you cannot find the video of the camera on the monitor screen or you have an unbundled camera, see the monitor installation and usage section for the pairing procedures.

- Mount the antenna onto the camera securely and keep the antenna straight.

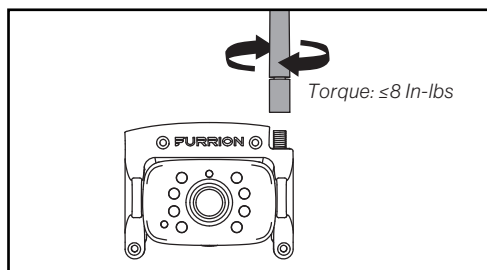

Install Cameras

- If there is a cover on the bracket housing, remove it first. Connect the female connector of the camera power cable to the male connector on the back of the camera, and put the redundant cables inside the bracket housing. Then attach the camera to the bracket with four #4x1/4" self-tapping screws.

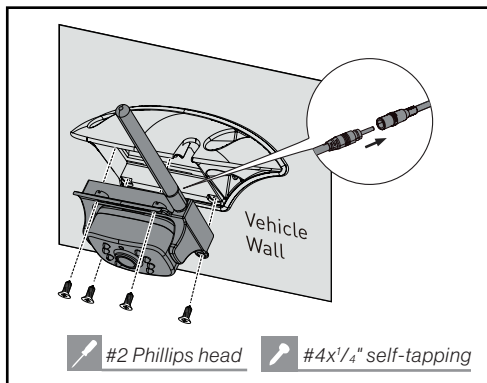

- Adjust the view angle of the camera by rotating it upwards and downwards (0-50°) so that you can see:
(For rear camera position): the bottom edge of your vehicle and the road conditions behind;
(For doorway camera position): the bottom edge of the door.

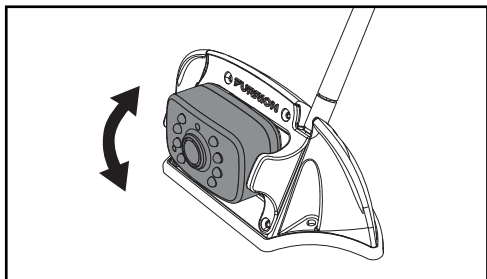

Install Cameras

Install Side Cameras & Rear Camera with Marker Light

Product overview

Side (Left/Right) cameras with marker light

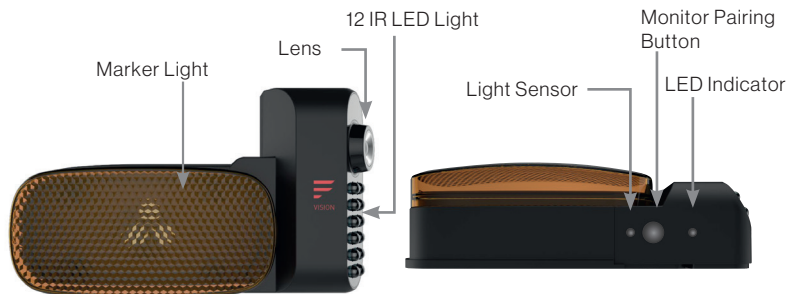

Rear camera

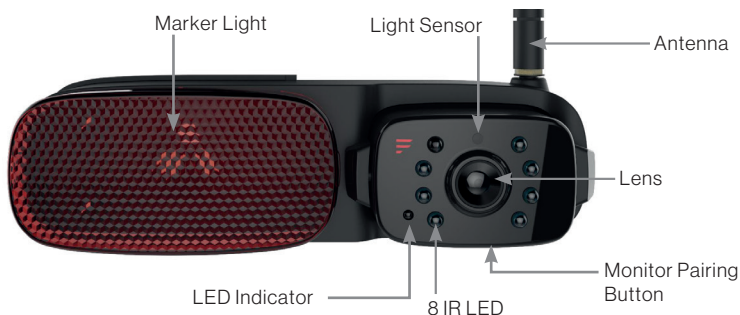

Prepare

- Prepare tools you may need, including # 1 and #2 Phillips head screwdrivers, sealant, insulation tape, pencil and/or a 5/8" drill bit (needed only when drilling a new hole).

Mount bracket

Note: Skip this section if your RV is pre-installed with a bracket for camera installation.

IMPORTANT: Before any installation and wiring operation, remove the key from the ignition and isolate the 12V / 24V power source.

Always seek professional assistance if you are unsure about the installation and wiring operation.

1. Determine the mounting location on your RV. Ensure that there is no obstacle blocking the camera view. To avoid drilling new holes, you are recommended to replace the original marker lights with Furrion products directly as shown below:

Install Cameras

- **For rear camera position:** Location of the original rear marker light at the top center on the rear of your RV. To accommodate the camera, ensure that there is at least 7.5" space between the central points of the two adjacent marker lights.
- **For side camera position:** Location of the original side marker lights (as front as possible).

Note: The RV shown here is for reference only. You can mount Furrion Vision S products onto various types of RVs such as trailers and Class A/B/C motorhomes.

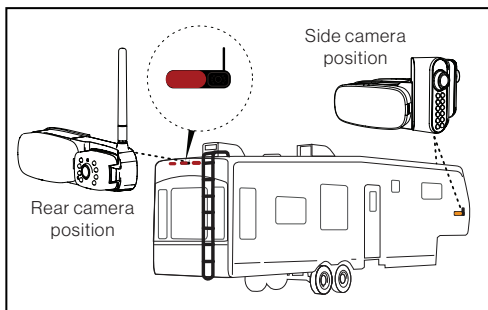

2. Remove the lens cover and detach the camera from the marker light bracket (right side camera shown).

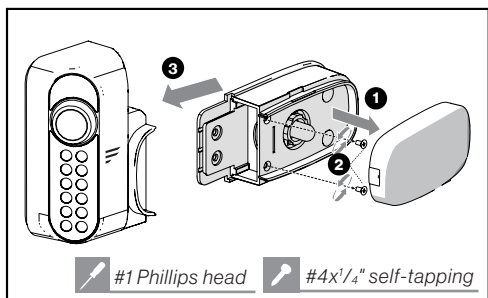

3. Remove the original marker light from the corresponding location.
4. Connect the bare ends of the power cable on the back of the bracket to the nearest 12V / 24V power supply: red_camera/ brown_marker light: +; black_grounding: -

- **For rear camera position:** You are suggested to use the power line for the original rear marker light directly.
- **For left/right side camera position:** You are suggested to use the power line for the original side marker lights directly.

Note: Ensure that the fuse on the connected power line provides additional 1A fusing current for the camera.

Ensure proper cable isolation for all bare ends (e.g., by using insulation tape).

5. Secure the gasket and marker light bracket onto your vehicle using four flat head #6 x 3/4" self-drilling screws. If the mounting surface is uneven, apply sealant between the gasket and RV surface, and around the 5/8" holes at the screw locations for better sealing.

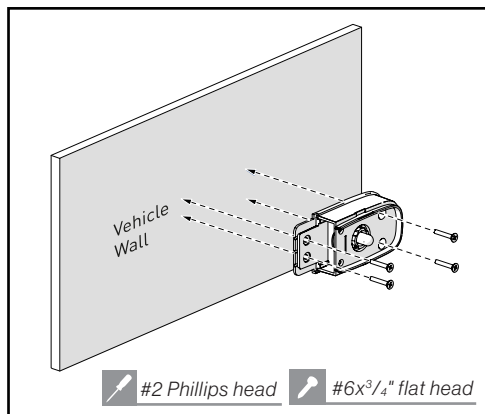

Install Cameras

Mount cameras (right side shown)

1. Reattach the camera to the marker light bracket. Before fixing the camera, check its pairing status with the monitor by resuming power temporarily. If you cannot find the video from the camera on the monitor screen or you have an unbundled camera, see the monitor installation and usage section for pairing procedures.

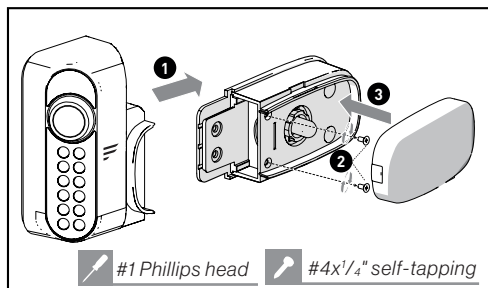

For the rear camera, mount the antenna onto the camera securely and keep the antenna straight.

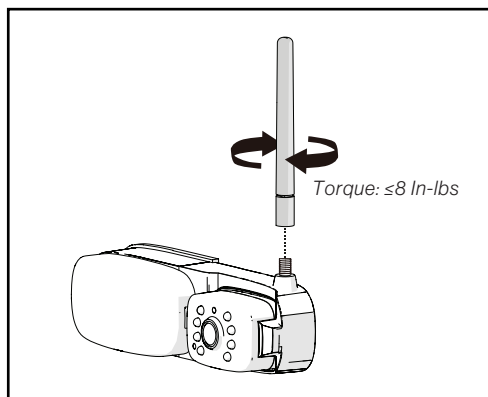

2. **For the left/right side camera,** ensure that the lens on the camera face backwards after installation, with the **MONITOR PAIRING** button at the bottom.

For the rear camera, adjust the view angle of the camera by rotating it upwards and downwards (0-50°) so that you can see the bottom edge of your vehicle and the road conditions behind.

Troubleshooting

Problem	Solution
Monitor won't turn on (no blue LED)	Check the power cable is connected.
	Check that the power supply has 12-24V DC output.
	Check all fuses and breakers (including fuses in the cigarette power adapter and fuse box).
	Power off and on again to reset.
Wireless camera(s) and monitor won't pair	Furrion monitor / rearview mirror can only pair with Furrion cameras. Pairing with products from other manufacturers is not supported.
	Check if the camera is receiving power. <ul style="list-style-type: none"> – Ensure that the fuse on the connected power line provides additional 1A fusing current for the camera. – Ensure proper cable isolation for all bare ends to avoid short-circuit.
	Make sure to hold the camera pairing button for 2 seconds.
Intermittent / weak signal icon appears	Check if the camera antenna is fitted and secured correctly - it should be vertical.
	Large dense objects could be obscuring the signal. If possible, move the objects.
	Interference from electrical appliances may be affecting the wireless signal. Turn off the appliances when using the system.
	Interference from overhead power lines may be affecting the signal.
	Try unpairing and pairing again.
Blurry images on the monitor	Remove the protective film from the camera lens upon completion of installation.
	The camera lens may be dirty. Wipe them with a piece of soft and clean cloth.
	Some adverse weather conditions such as heavy fog, rain, floating dust or mud splashes may either partially or entirely block the camera view. Clean the camera lens immediately after driving to a safe place.
Images too dark / bright on the monitor	Adjust the brightness and contrast settings.
	The image may be too bright when the camera lens are facing towards a direct light source. This is not a malfunction.
Night vision is poor or does not function	The light sensor on the camera may be dirty or obstructed. Clean the light sensor or remove obstacles.
	If the ambient light is too strong, the night vision function may not engage. This is not a malfunction.
	Ensure that the camera is installed at least 2 inches away from marker lights.

Troubleshooting

Problem	Solution
Monitors Blue LED off with no picture	The camera has no power connected.
	Ensure the tow vehicle is running.
	Ensure the 7 way connector is connected.



FURRION

Furrion Innovation Center & Institute of Technology

- 52567 Independence Ct., Elkhart, IN 46514, USA • Toll free:1-800-789-3341
- Email: support@furrion.com

©2007-2021 Furrion Ltd. Furrion® and the Furrion logo are trademarks licensed for use by Furrion Ltd. and registered in the U.S. and other countries.

For Patent Info: www.furrion.com/pages/patents

www.furrion.com